

EVOKE 
CONNECTING THE OUTSIDE

The **evoke flush range**

EVOKE FLUSH

The aluminium system with the **slimmest sightlines on the market**

The Evoke flush range, it's designed for high performance and to be simple to install.

It provides solutions for the typical problems trade installers face with other aluminium systems.

No need for onsite scaffolding, it's quick to glaze and with the unique reverse butt joint option eliminating the need for dummy sashes or adaptors, you can maintain internal glazing with more affordable designs.

The system is 30% slimmer than its main competitors*, delivering the best sightlines for the bright, light look everyone wants. It can reach WERs of Band A+ and has aesthetics that are at home in both contemporary and traditional properties. It is secure, low maintenance and more sustainable.





Less frame, more light

Evoked's frames are 30% slimmer than those of the closest competitor. Based on an internally-glazed GGF standard window, with Evoke, there's an extra 12% glass area.



Swift installation

Flat rebates are easy to maintain and can save a couple of minutes per sash when fitting glazing packers. Evoke's frames also have a flat back that's easier to pack when you're on site.



Reduced cost, reduced waste

Evoked uses approximately 30% less aluminium than comparable systems. It's therefore more affordable, more sustainable and less likely to generate waste.



Cleaner lines and adaptable style

The Evoke flush range has clean lines and the option of a genuine fully-flush casement. It has a contemporary style that also works with more traditional architecture. With a 36mm cill that replicates timber, it's also ideal for conservation areas.



Thermal performance

Strong aluminium sections allow large glazed areas, while advanced thermal break technology ensures no compromise on insulation. Evoke flush can reach a WER of Band A+ and U-values of 1.2W/m²K with triple glazing.



More integration

Evoked is also compatible with PVC-U cills and trims.



Offers **12% more glass area**



Market-leading slim sightlines - **30% slimmer sightlines** than main competitors



Knock in bead with pre-inserted gasket which makes the system **20% quicker to install**



Consistent glass lines: Profile designed to keep the glass aligned for casement and fixed lights



Innovative patent-pending reverse butt joint: fabrication without the need for dummy sashes or reverse adaptor profiles



Flush inside and out:
choice of two sashes



Easy-clean rebates



Tailed gasket to **improve thermal performance**

FASTER INSTALLATION



Evoke uses knock-in beads. Without wedge gaskets, glazing is faster.



Flat, easy-clean rebates make glazing packers easy to fit.



Frames are flat backed, so easier to pack during installation.



Internal glazing as standard avoids the need for scaffolding.



Thresholds can be replaced without disturbing the doorframe.

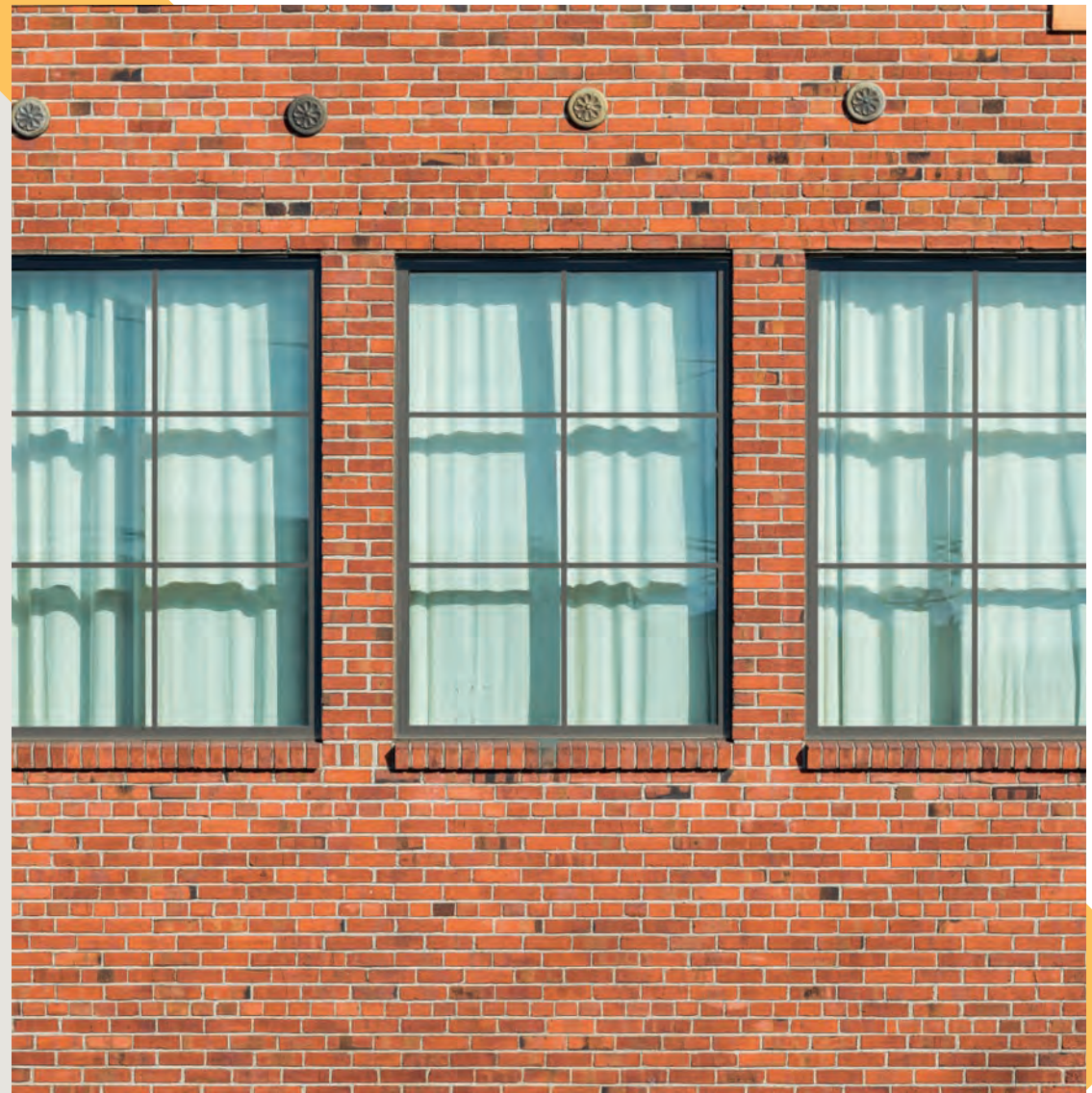

THE EVOKE WINDOW RANGE

Everything you need is included in the Evoke window range.

The system is complete and has dedicated ancillary products so that whatever your customer is looking for, you've got the answer.

The layout of windows – the number of fixed and opening panes, the simplicity of the lines or the extra details that give character – everything is adaptable, and every component is designed to work together.

There are two types of casement: a standard flush design with a stepped shape internally, and a fully-flush option with flush lines inside and outside. Bay and bow windows are no problem – all the assemblies needed, all the trims and all the cills are included in the Evoke system. Where astragal bars are required, Evoke has them. If you want the advantages of a two-part cill, it's yours.

WER
up to Band
A+



U-values
can be as low
as 1.1W/m²K



Air
permeability
tested to 600Pa



Water
tightness to
600Pa



Wind load
resistance to
2000Pa



Can be
double or triple
glazed



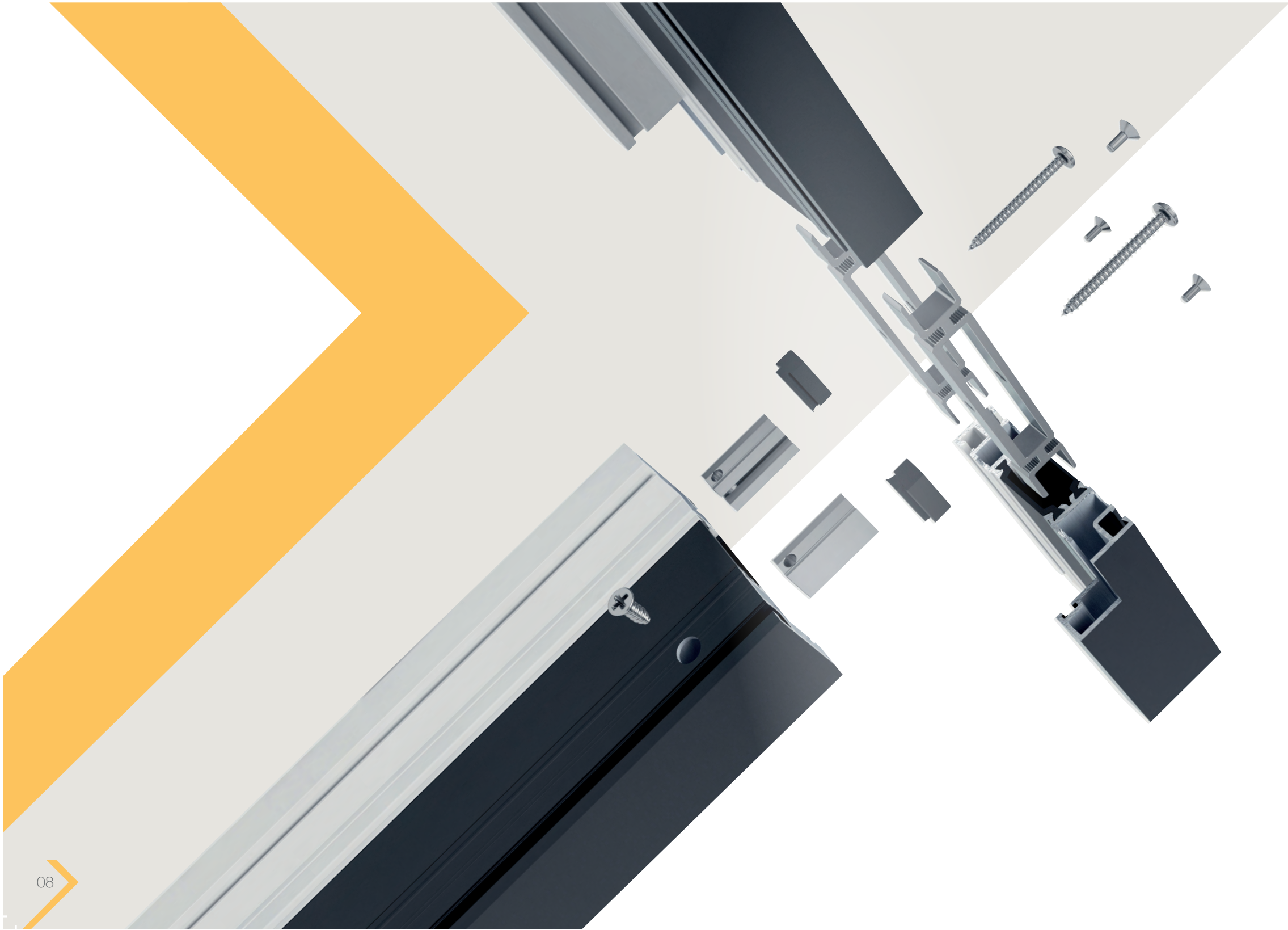

THE INNOVATIVE REVERSE BUTT JOINT

Most aluminium systems compromise and use dummy sashes, couplers or reverse rebate adaptors to ensure their windows can be internally glazed.

Unfortunately, this detracts from the appearance of windows and uses more resources.

The Reverse Butt Joint from Evoke flush range is unique. It's a patent-pending design which solves the problem, allowing internally glazed windows without the extra, chunky sashes. The window's wonderful slim lines are preserved, and more daylight can enter your home.

- › Improved appearance with simple, clean styling
- › Internal glazing without compromise
- › Uses less material, therefore, more planet friendly
- › Lighter, brighter homes
- › More affordable design





Evoked 70 flush casement window

Designed for a flush appearance to the exterior, finished frames have a neat step internally. The system allows for almost any arrangement of top or side-hung sashes and fixed lights, with the revolutionary reverse butt joint removing the need for adaptors and dummy sashes.



Dimensions

- › Side-hung sash – max 700mm x 1300mm
- › Top-hung sash – max 1200mm x 1200mm.
- › Sightline (frame to vent) 61.5mm
- › Sightline (vent to mullion) 79.5mm
- › Sightline (fix light) 36mm
- › Glazing thickness: 28-44mm



Performance

- › WER up to Band A+ with triple glazing
- › U-values as low as 1.2W/m²K
- › Meets Building Regs without foams or special polyamides.



Aesthetics

- › Market-leading slim sightlines
- › Astragal bars
- › Thicker cill to replicate timber
- › Needs no dummy sashes
- › Flush sash
- › Square look.



Installation

- › Flat back to frames
- › Flat rebates for easy-fit glazing packers
- › Knock-in beads.



Guarantees

- › 10-year mechanical performance guarantee
- › 25-year surface paint finish guarantee
- › Lifetime security guarantee on hardware.



Evoked 70 fully flush casement window

A true, interior and exterior, fully-flush design that makes the most of Evoke's ultra-slim styling. The advantage of the reverse butt joint allows frames of almost any layout to be made without the complexity or expense of dummy sashes or adaptors.



Dimensions

- › Side-hung sash – max 700mm x 1300mm
- › Top-hung sash – max 1200mm x 1200mm
- › Sightline: (frame to vent) 75mm
- › Sightline: (vent to mullion) 93mm
- › Sightline: (fix light) 36mm
- › Sightline thickness: 28mm - 44mm.



Performance

- › WER up to Band A+ with triple glazing
- › U-values as low as 1.1W/m²K
- › Meets Building Regs without foams or polyamides
- › 40mm and 45mm polyamide thermal breaks to compensate for larger sightline.



Aesthetics

- › True flush sash indoors and out (no stepped frame)
- › Astragal bars
- › Market-leading slim sightlines
- › Thicker cill to replicate timber
- › Needs no dummy sashes
- › Square look.



Installation

- › Flat back to frames
- › Flat rebates for easy-fit glazing packers
- › Up to 44mm triple glazing
- › Same bead as fixed light
- › Knock-in beads.



Guarantees

- › 10-year mechanical performance guarantee
- › 25-year surface paint finish guarantee
- › Lifetime security guarantee on hardware.

Evolve 70 window **cross** **section drawings**



External Flush

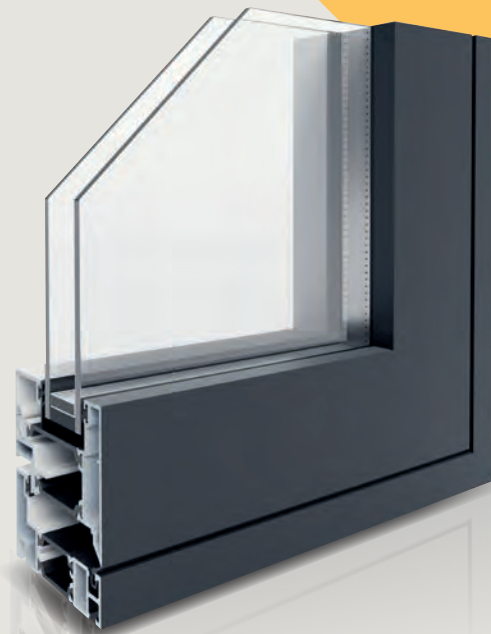

Fully Flush



Reverse Butt

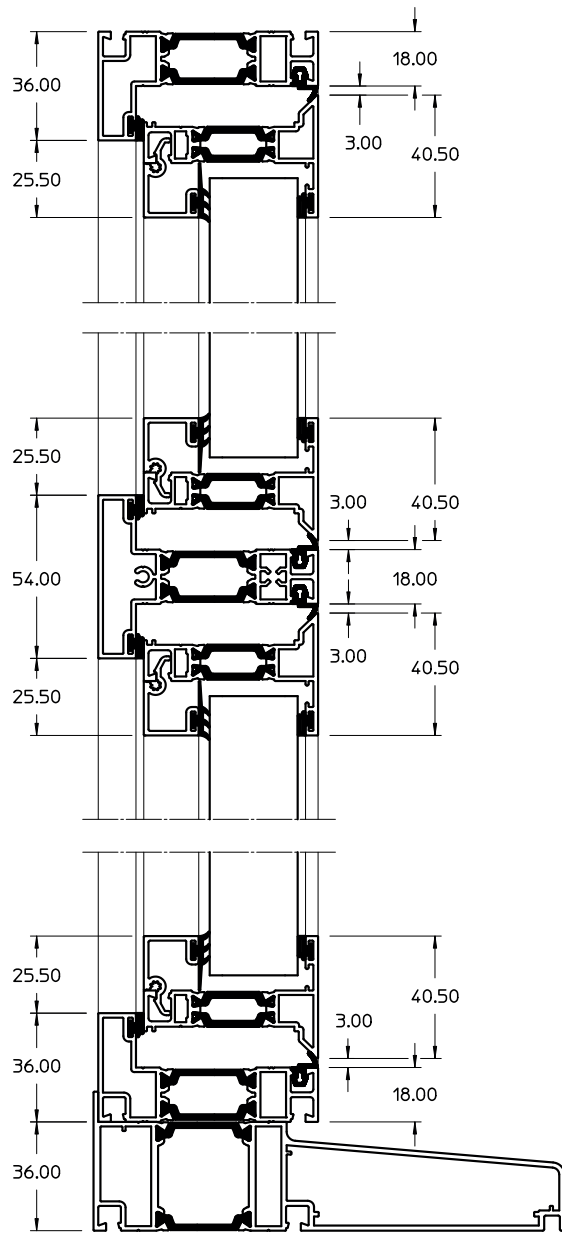

External Flush

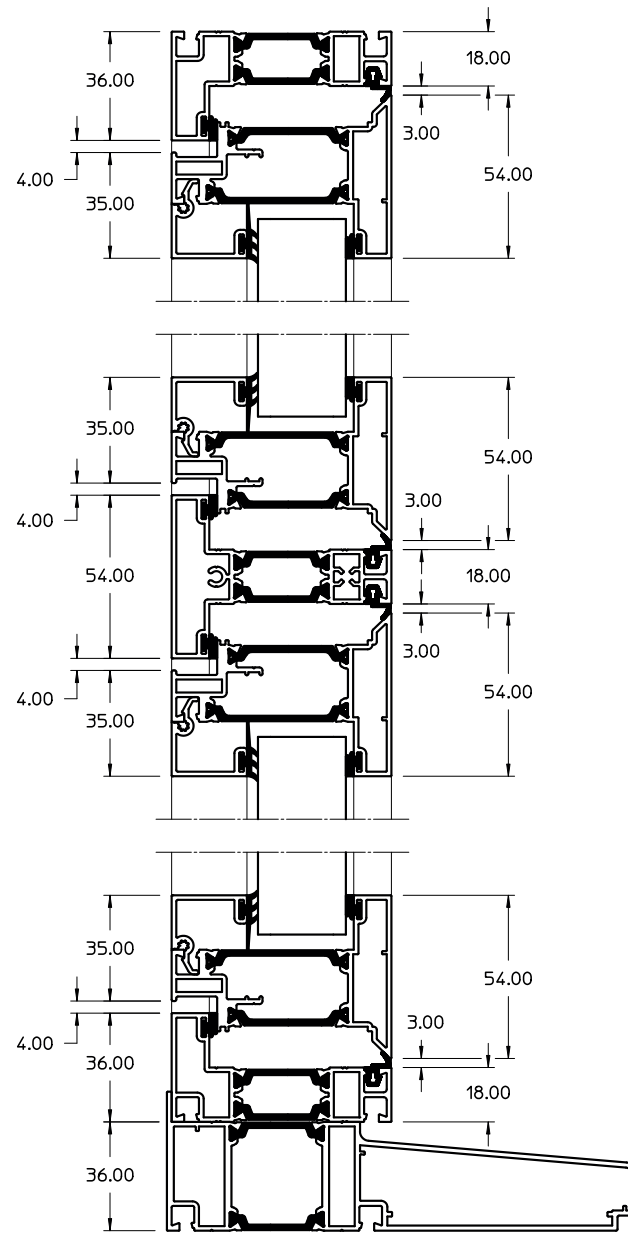

Fully Flush

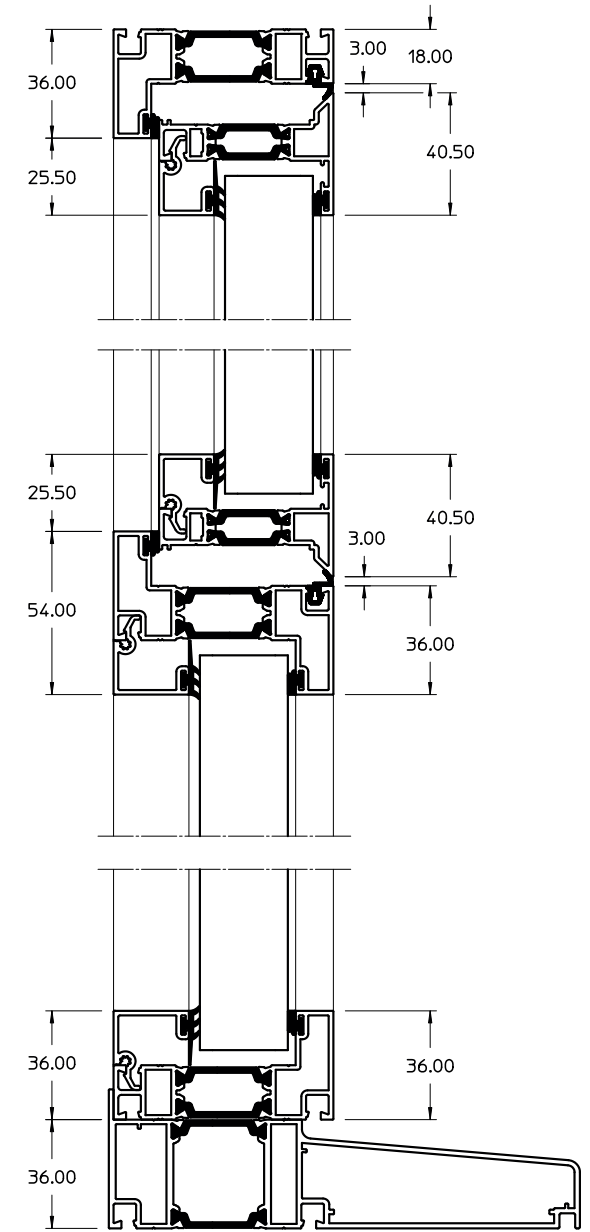

Reversed Butt

All cross section drawings shown are when using the WQ01 slim outerframe. Other frames are available as shown on page 18.



Bay window

Bay and bow windows, like every other part of the Evoke Flush range, can be customised to your project needs. The styling can be kept plain and simple, but it's also possible to incorporate decorative features like glazing bars and stained glass.

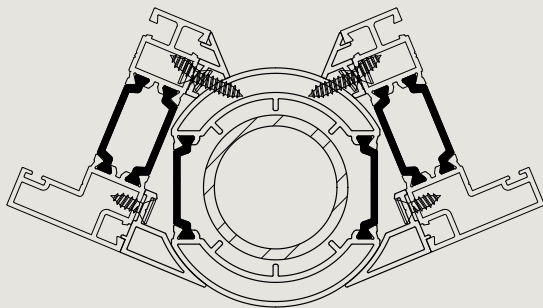

Variable Baypole

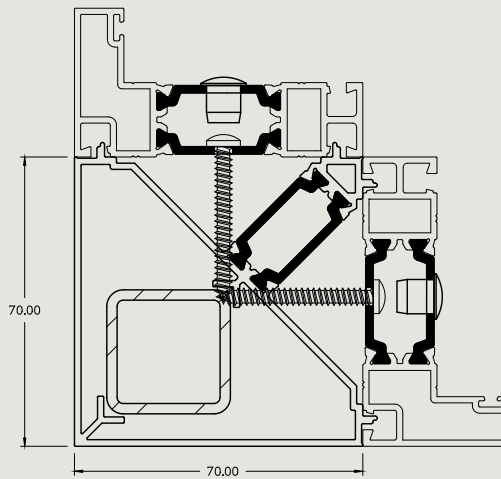

90 degree Baypole

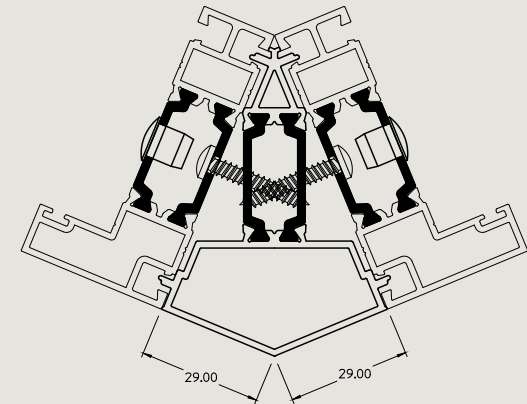

135 degree Baypole

Aluminium flush casement window and doors main components

Main profiles

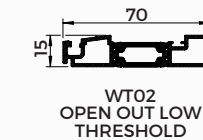
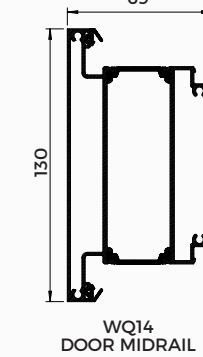
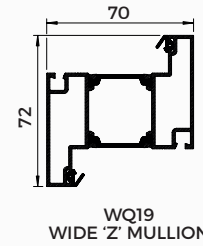
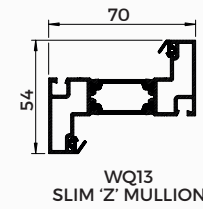
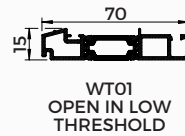
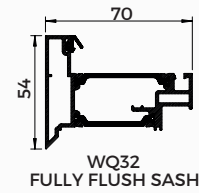
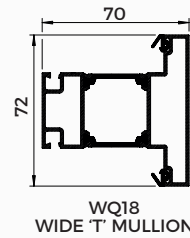
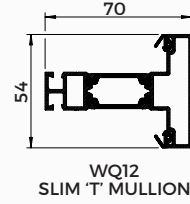
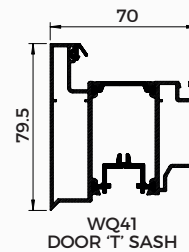
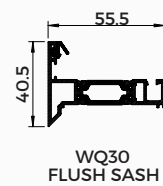
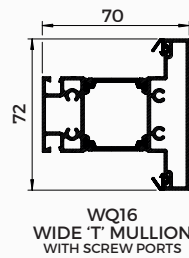
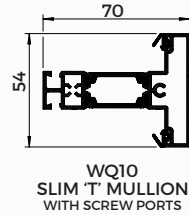
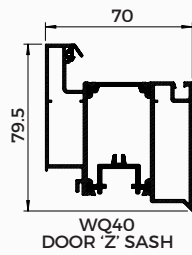
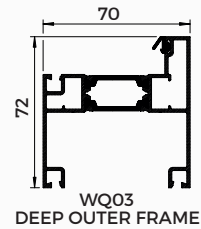
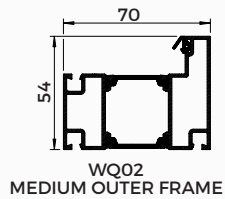
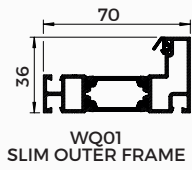

Glazing beads





Aluminium flush casement window and doors 70mm accessories

Ancillaries

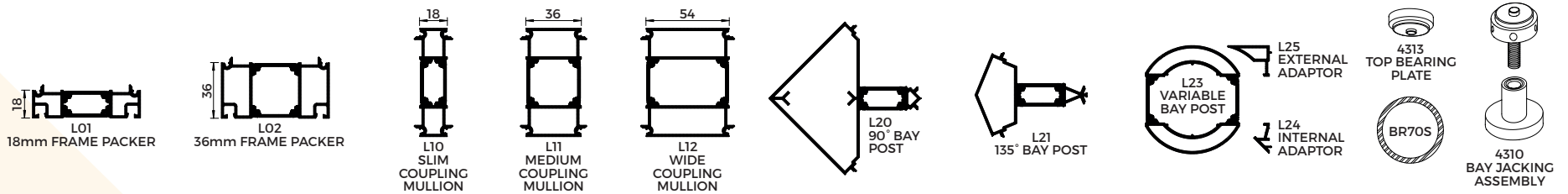

Cills

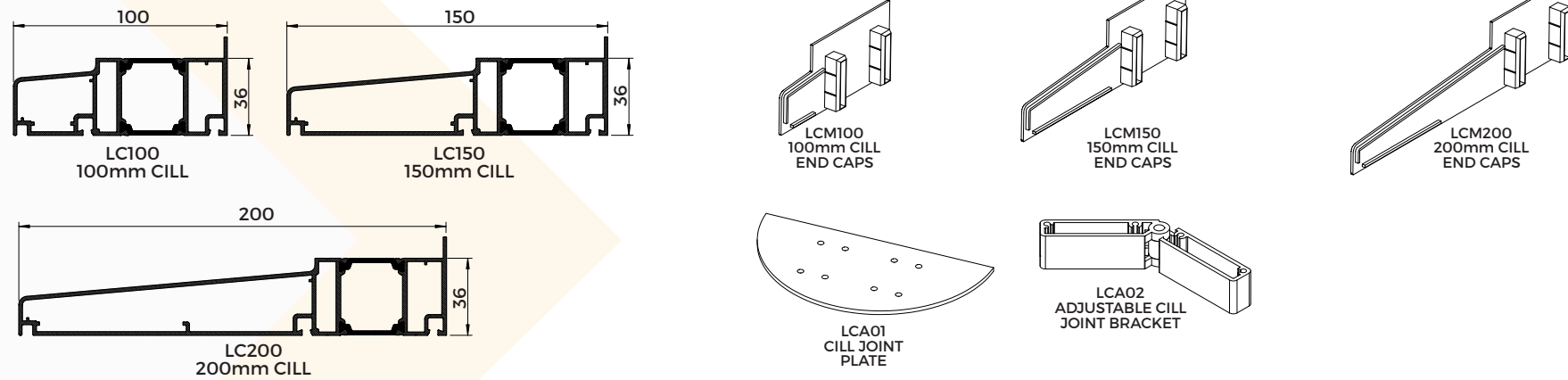

THE EVOKE DOOR RANGE

It's easy to achieve consistency in style with Evoke – the flush door is possible with this advanced aluminium system.

Evoke has been developed to be reassuringly robust in an entrance door and graceful enough for a classic French door.

Evoke is versatile. Fanlights and sidelights can easily be incorporated in doorsets. There are purpose-made midrails, a full range of cills and thresholds and every element has been tested and proven to deliver excellent long-term performance. Domestic or commercial, whatever your market, with Evoke, there's a door that's easy to install and fits to perfection.

WER
up to Band
A+



U-values
can be as low
as 1.1W/m²K



Air
permeability
tested to 600Pa



Water
tightness to
600Pa



Wind load
resistance to
2000Pa



Can be
double or triple
glazed





Evoked Flush residential and French doors

Evoked is a highly configurable system, ideal for standard front and rear entrance doors or French doors. Side panels and fanlights can easily be incorporated into doorsets.

These doors also benefit from superior quality hardware. Selected for reliable performance, tested through cycle after cycle – locks, hinges, handles – every single element contributes to a secure, robust and very stylish system.



Dimensions

- › Door leaf – max 1000mm x 2400mm
- › Glazing thickness 24mm - 40mm
- › Sightline (Frame to Vent) 75mm.



Operation

- › Open-in or open-out with either full-frame or low threshold
- › Part M compliant low threshold.



Performance

- › U-values as low as 1.3W/m²K with triple glazing
- › Meets Building Regs without foams or special polyamides.



Aesthetics

- › Slim sightlines
- › Flush indoors and out.



Installation

- › Flat back to frames
- › Flat rebates for easy-fit glazing packers
- › Thresholds can be replaced with frame in situ
- › Knock-in beads.



Guarantees

- › 10-year mechanical performance guarantee
- › 25-year surface paint finish guarantee
- › Lifetime security guarantee on hardware.

Evolve door cross section drawings



Single Door

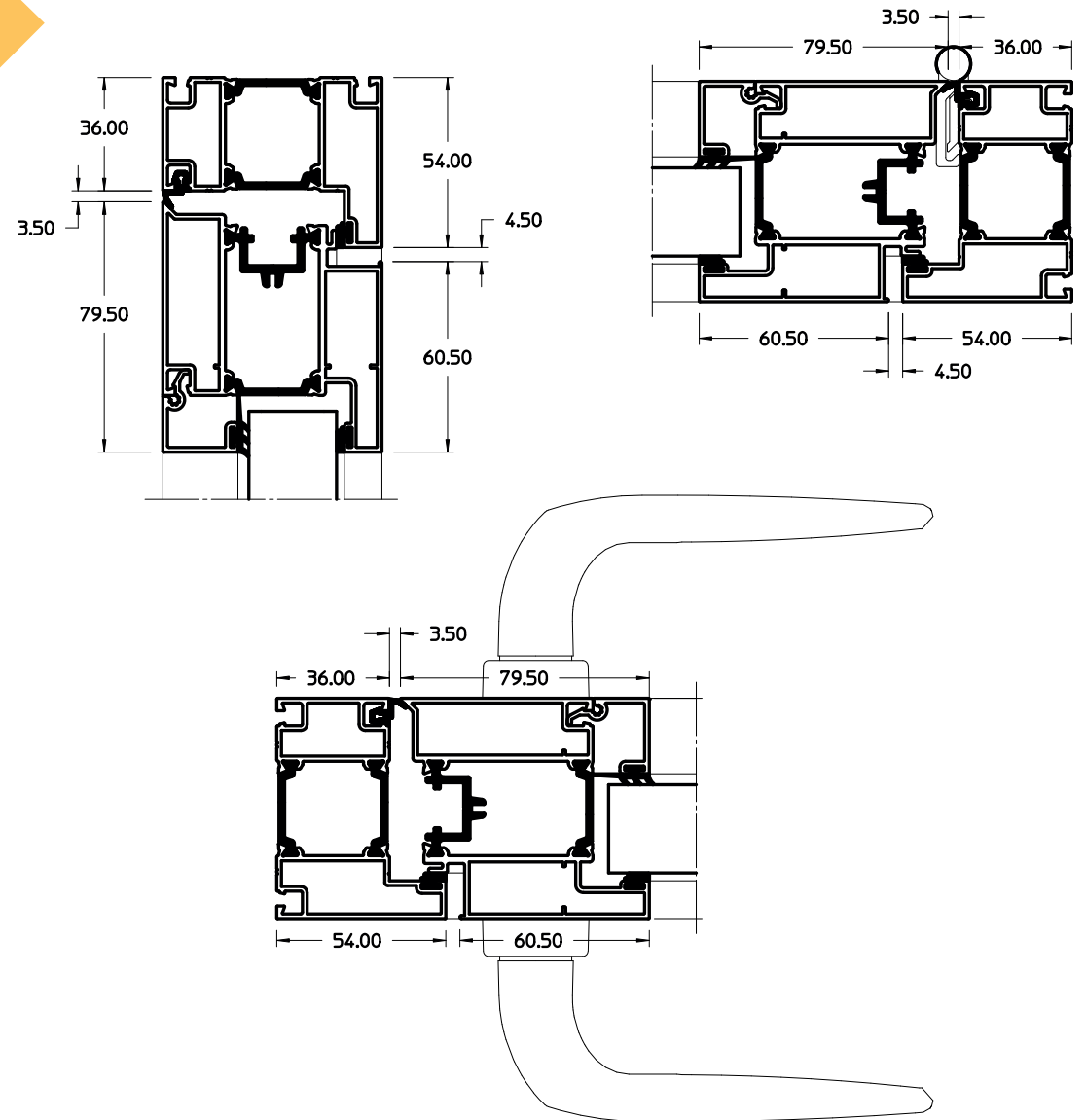



Double Doors

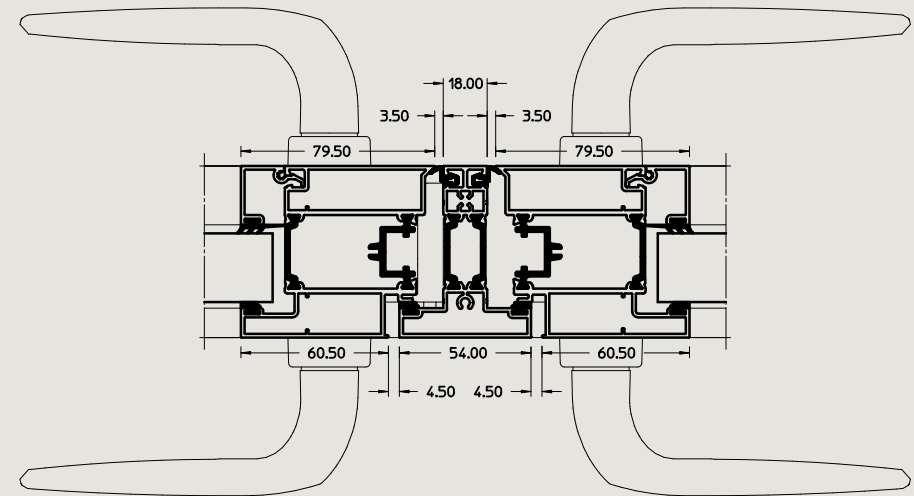
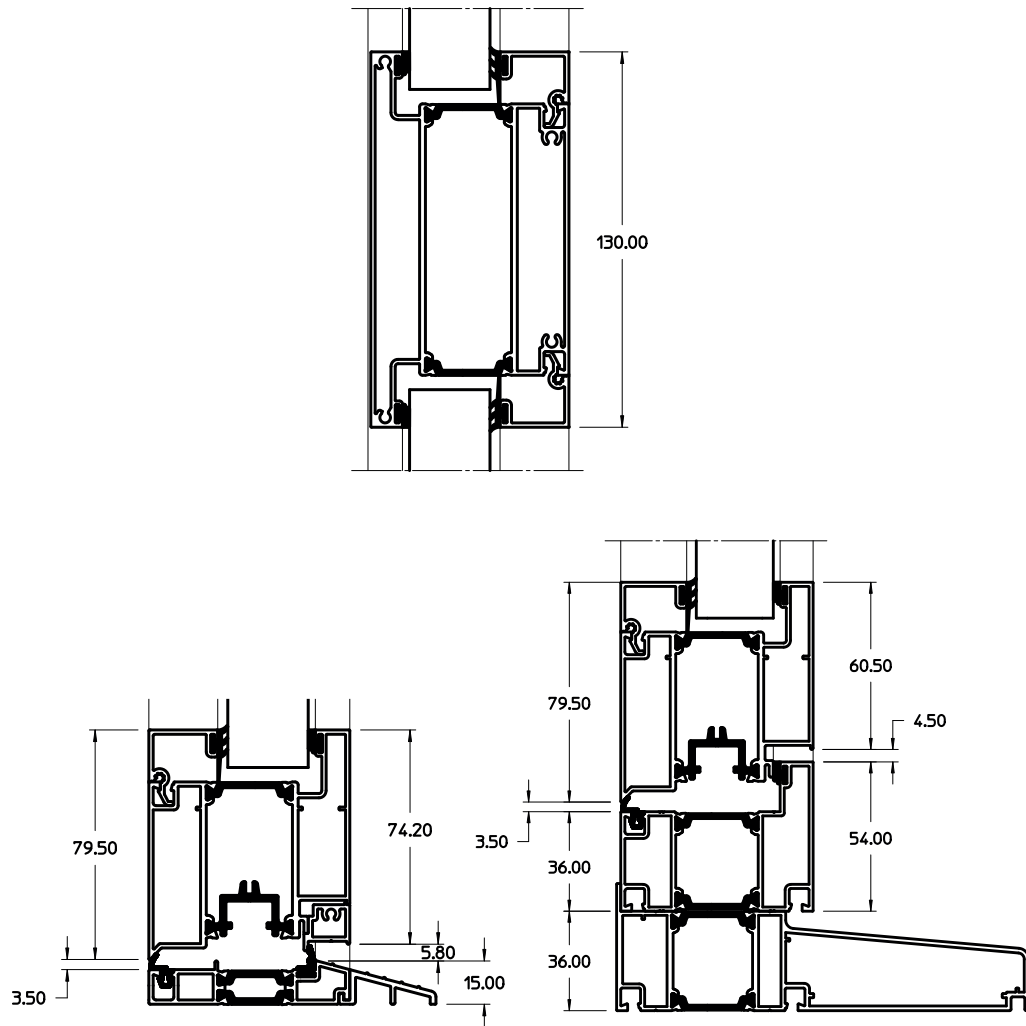

All cross section drawings shown are when using the WQ02 medium outerframe. Other frames are available as shown on page 18.

Evoked flush handles

We have selected products known for their reliability, ease of use and durability, and every item in the range has undergone rigorous testing. The range includes styles and finishes to suit all projects.

Casement window

Evoked's Flush and Fully Flush windows utilise high-quality hardware throughout. Friction stays are robust and reliable. Espags have been selected for ease of fitting, PAS24 compliance and corrosion resistance. Handles are proven, stylish and benefit from key locking and easy operation. Hinge protectors and cavity locking blocks are simple to adjust and easy to work with. For extra piece of mind all PAS24 compliant casement windows come with Yale's Lifetime Security Guarantee.

Flush door

Security, weather protection and ease of use were paramount in the selection of hardware for both Evoked's flush residential door and the French doors, but style hasn't been forgotten – handles suite perfectly with window handles and letterplates have clean modern styling and an immaculate finish. Doors fitted with the Yale 3-star cylinder and conforming to PAS24 carry the Yale Lifetime Security Guarantee. All door hardware is easy to fit, quick to adjust and proven for long-term



Evoked flush finishes

Colour can make a huge difference to the overall success of a glazing project, and in architectural terms, it can be a fundamental part of the whole project. That's why Evoke's colour palette isn't limited.

Different eras and building materials demand different finishes, sometimes subtle, sometimes bold. We can supply profiles finished with any gloss level, in any RAL colour, or any dual colour combinations. There really is no limit to the colours you can choose, enabling you to satisfy more customers and fulfil the aesthetic requirements of more construction projects.

All Evoke's aluminium sections are finished with a tough, durable polyester powder coat, certified to the Qualicoat standard, which surpasses European requirements. In addition, we can supply special marine-grade finishes for more challenging environments.



Standard Stock

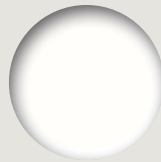

Signal White
Flat/Matt
RAL 9003



Anthracite Grey
Flat/Matt
RAL 7016

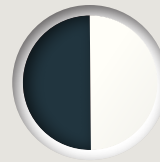

Anthracite Grey/Signal White
Flat/Matt
RAL 7016 / 9003

Standard Non Stock

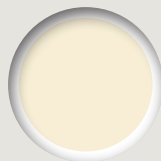

Cream
Flat/Matt
RAL 9001

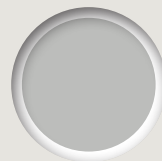

Agate Grey
Flat/Matt
RAL 7038



Slate Grey
Flat/Matt
RAL 7015



Chocolate Brown
Flat/Matt
RAL 8017

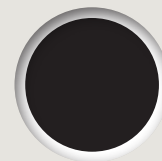

Jet Black
Flat/Matt
RAL 9005



Anthracite Grey
Textured
RAL 7016

All above colours are Evoke standard stock and non stock finishes. All other RAL colours or any dual colour combinations, gloss levels are available on request.

EVOKE

CONNECTING THE OUTSIDE



Evoke is an aluminium profile system supplied to local independent manufacturers and installers who contract to install windows and doors. Evoke cannot be held accountable for manufacture or installation by independent companies. All information in this publication is provided for guidance only and is given in good faith. As it is company policy to continually improve products, methods and materials, changes of specification may be made from time to time without prior notice. This statement does not affect your statutory rights. © Evoke.